



# Musts For USTs

EPA wrote this booklet for owners and operators of underground storage tanks (USTs).

This booklet describes the 2015 revised *federal* UST regulation. Many states and territories (referred to as states in this booklet) have state program approval from EPA. To find a list of states with state program approval, see [www.epa.gov/ust/state-underground-storage-tank-ust-programs](http://www.epa.gov/ust/state-underground-storage-tank-ust-programs).

If your UST systems are located in a state *with* state program approval, your requirements may be different from those identified in this booklet. To find information about your state's UST regulation, contact your implementing agency or visit its website. You can find links to state UST websites at [www.epa.gov/ust/underground-storage-tank-ust-contacts#states](http://www.epa.gov/ust/underground-storage-tank-ust-contacts#states).

If your UST systems are located in a state *without* state program approval, both the requirements in this booklet and the state requirements apply to you.

If your UST systems are located in Indian country, the requirements in this booklet apply to you.

## *Free Publications About UST Requirements*

See EPA's underground storage tank (UST) website at [www.epa.gov/ust](http://www.epa.gov/ust) to order, download, or read documents online. Write to the National Service Center for Environmental Publications (NSCEP), EPA's publication distributor: NSCEP, PO Box 42419, Cincinnati, OH 45242. Call NSCEP's toll-free number 800-490-9198. Fax your order to NSCEP 301-604-3408.

### Image credits:

MVI Field Services (inspector on cover and page 21)

Highland Tank & Manufacturing Company (steel tanks on cover and in headers)

OPW (fill sump on cover, spill bucket on page 7, automatic shutoff device on page 8, ball float valve on page 9)

Federated Environmental Associates, Inc. (under-dispenser containment on page 5, spill bucket on page 10, delivery on page 11)

# Contents



<b>What Is This Regulation About?</b> .....	<b>1</b>
<b>What Must You Do When You Install An UST?</b> .....	<b>5</b>
<b>What Must You Report?</b> .....	<b>6</b>
<b>What Are Your Spill And Overfill Prevention Requirements?</b> .....	<b>7</b>
<b>What Are Your Corrosion Protection Requirements?</b> .....	<b>12</b>
<b>What Are Your Release Detection Requirements?</b> .....	<b>15</b>
<b>What Must You Do For Walkthrough Inspections?</b> .....	<b>21</b>
<b>Compatibility With Biofuels And Other Regulated Substances</b> .....	<b>23</b>
<b>What Are The Operator Training Requirements?</b> .....	<b>25</b>
<b>How Do You Repair UST Systems?</b> .....	<b>26</b>
<b>Financial Responsibility</b> .....	<b>28</b>
<b>What Must You Do About UST Releases?</b> .....	<b>29</b>
<b>How Do You Close USTs?</b> .....	<b>31</b>
<b>What Records Must You Keep?</b> .....	<b>33</b>
<b>For Hazardous Substance USTs Only</b> .....	<b>34</b>
<b>Links For More Information</b> .....	<b>36</b>

## Disclaimer

This document provides information about the 2015 federal underground storage tank (UST) system requirements. The document is not a substitute for U.S. Environmental Protection Agency regulations nor is it a regulation itself — it does not impose legally binding requirements.

For regulatory requirements regarding UST systems, refer to the federal regulation governing UST systems (40 CFR part 280).



# What Is This Regulation About?



As of 2015, the U.S. Environmental Protection Agency (EPA) regulates over one-half million underground storage tank systems (USTs) that contain petroleum or hazardous substances. EPA's Office of Underground Storage Tanks was formed in response to the discovery in the early 1980s that thousands of USTs had leaked and contaminated groundwater supplies in the United States. While the number of annual releases since that time has gone down significantly, releases of petroleum from USTs into the environment are still a significant concern today. Underground storage tanks form a crucial part of our country's fueling infrastructure. It is important for USTs to be constructed, maintained, and operated in a manner such that petroleum and other regulated substances are stored safely. EPA developed the UST regulation to help owners and operators meet those goals.

A properly installed and managed UST system should not threaten our health or environment. Congress passed federal laws, which required EPA to develop the UST regulation described in this booklet. The federal UST regulation in 40 Code of Federal Regulations (CFR) part 280 requires owners and operators of USTs to:

- Prevent releases from USTs;
- Detect releases from USTs; and
- Correct the problems created by releases from USTs.

In addition, the regulation requires UST owners and operators maintain documentation showing they have the ability to pay for cleaning up a release if their USTs leak.

## How Will The UST Regulation Affect You?

The UST regulation describes steps you, as an UST owner or operator, must take to help protect our health and environment from potential UST releases. These steps will also help you avoid the high cost of cleaning up the environment and possible legal actions if your UST system leaks.

---

Releases from USTs can threaten human health and the environment, contaminating both soil and groundwater. As of 2015, more than 525,000 UST releases have been confirmed.

---

---

Your implementing agency may be the state UST agency, EPA, or a local UST agency.

---

## Check With Your Implementing Agency

Many states and territories (referred to as states in this booklet) have state program approval from EPA. To find a list of states with state program approval, see [www.epa.gov/ust/state-underground-storage-tank-ust-programs](http://www.epa.gov/ust/state-underground-storage-tank-ust-programs).

If your UST systems are located in a state *with* state program approval, your requirements may be different from those identified in this booklet. Check with the state UST program in the state where your USTs are located for your state's requirements.

If your UST systems are located in a state *without* state program approval, both the requirements in this booklet and the state requirements apply to you.

If your UST systems are located in Indian country, the requirements in this booklet apply to you.

## What Is An UST?

An UST is one or more tanks and any underground piping connected to the tanks that have at least 10 percent of their combined volume underground. The federal UST regulation applies only to USTs storing petroleum, petroleum blended with biofuels, and certain other hazardous substances.

The *For Hazardous Substance USTs Only* section on pages 34-35 describes special requirements for USTs storing hazardous substances. Generally, the requirements for petroleum USTs and hazardous substance USTs are very similar.

Some kinds of tanks are not covered by this regulation:

- Farm and residential tanks of 1,100 gallons or less capacity holding motor fuel used for noncommercial purposes.
- Tanks storing heating oil used on the premises where it is stored.
- Tanks on or above the floor of underground areas, such as basements or tunnels.
- Septic tanks and systems for collecting stormwater and wastewater.
- Flow-through process tanks.
- Emergency spill and overfill tanks.
- Other storage sites, such as surface impoundments.

*A list of state contacts can be found at [www.epa.gov/ust/underground-storage-tank-ust-contacts#states](http://www.epa.gov/ust/underground-storage-tank-ust-contacts#states).*

*The 2015 UST regulation removes the deferral for field constructed tanks and airport hydrant systems, making them subject to all of the UST requirements. Because these UST systems can be large and unique when compared to conventional UST systems, some of the requirements are different from those described in this booklet. Therefore, these systems are not covered in this booklet. Please see EPA's field constructed tanks and airport hydrant systems website at [www.epa.gov/ust/field-constructed-tanks-and-airport-hydrant-systems-2015-requirements](http://www.epa.gov/ust/field-constructed-tanks-and-airport-hydrant-systems-2015-requirements).*

## What Are Your Requirements?

The requirements listed below include 1988 requirements plus 2015 requirements and their implementation dates. **Throughout this document, bold type and orange updated boxes indicate new requirements in the 2015 UST regulation.** Remember you need to keep records for most of these requirements. See page 33 for your recordkeeping requirements.

	For These Tanks Or Facilities:	You Must Have This Equipment Or Perform These Actions:
		<b>Installation (page 5)</b>
UPDATED	All Tanks	<ul style="list-style-type: none"> <li>If you install an UST system, meet the requirements concerning correct installation</li> <li><b>Under-dispenser containment for new dispensers installed after April 11, 2016</b></li> </ul>
		<b>Reporting (page 6)</b>
UPDATED	All Facilities	<ul style="list-style-type: none"> <li>After you bring an UST system into use, notify your implementing agency within 30 days</li> <li>Notify your implementing agency at least 30 days before permanently closing an UST</li> <li><b>Notify your implementing agency within 30 days of acquiring an UST</b></li> <li><b>Notify your implementing agency at least 30 days before switching to regulated substances blended with greater than 10 percent ethanol or greater than 20 percent biodiesel or other regulated substances identified by your implementing agency</b></li> </ul>
		<b>Spill And Overfill Prevention (pages 7-11)</b>
UPDATED	All Tanks Installed On Or Before October 13, 2015 Ever Receiving Deliveries Greater Than 25 Gallons	<ul style="list-style-type: none"> <li>Spill buckets</li> <li>Automatic shutoff devices <i>or</i> overfill alarms <i>or</i> ball float valves<sup>1</sup></li> <li>Use correct filling practices</li> <li><b>No later than October 13, 2018, begin testing spill buckets every three years<sup>2</sup></b></li> <li><b>No later than October 13, 2018, begin inspecting overfill prevention equipment every three years</b></li> </ul>
UPDATED	All Tanks Installed After October 13, 2015 Ever Receiving Deliveries Greater Than 25 Gallons	<ul style="list-style-type: none"> <li>Spill buckets</li> <li>Automatic shutoff devices <i>or</i> overfill alarms</li> <li>Use correct filling practices</li> <li><b>Test spill buckets every three years<sup>2</sup></b></li> <li><b>Inspect overfill prevention equipment every three years</b></li> </ul>
		<b>Corrosion Protection (pages 12-14)</b>
	Tanks And Piping Installed On Or Before December 22, 1988	<ul style="list-style-type: none"> <li>Same options as for tanks and piping installed after December 22, 1988; <i>or</i></li> <li>Cathodically protected steel; <i>or</i></li> <li>Tank interior lining; <i>or</i></li> <li>Tank interior lining <i>and</i> cathodic protection</li> <li>Cathodic protection testing and internal lining inspections</li> </ul>
	Tanks And Piping Installed After December 22, 1988	<ul style="list-style-type: none"> <li>Coated and cathodically protected steel; <i>or</i></li> <li>Noncorrodible material, such as fiberglass reinforced plastic (FRP) or flexible plastic (piping only); <i>or</i></li> <li>Steel tank clad or jacketed with noncorrodible material (tanks only)</li> <li>Cathodic protection testing</li> </ul>
		<b>Release Detection (pages 15 20)</b>
	Tanks Installed On Or Before April 11, 2016 <sup>3</sup>	<ul style="list-style-type: none"> <li>Monthly monitoring;<sup>4</sup> <i>or</i></li> <li>Manual tank gauging;<sup>5</sup> <i>or</i></li> <li>Inventory control or manual tank gauging<sup>4</sup> plus tank tightness testing (only for 10 years after installation)</li> </ul>
UPDATED	Pressurized Piping Installed On Or Before April 11, 2016 <sup>3</sup>	<ul style="list-style-type: none"> <li>Automatic line leak detector; <i>and</i></li> <li>Annual line tightness test <i>or</i></li> <li>Monthly monitoring<sup>4</sup> (except automatic tank gauging)</li> <li><b>No later than October 13, 2018, begin testing containment sumps used for piping interstitial monitoring every three years<sup>2</sup></b></li> </ul>

	<b>For These Tanks Or Facilities:</b>	<b>You Must Have This Equipment Or Perform These Actions:</b>
UPDATED	Suction Piping Installed On Or Before April 11, 2016 <sup>3</sup>	<ul style="list-style-type: none"> <li>Monthly monitoring;<sup>4</sup> or</li> <li>Line tightness testing (every 3 years); or</li> <li>No requirements (if the system has the characteristics described on page 19)</li> <li><b>No later than October 13, 2018, begin testing containment sumps used for piping interstitial monitoring every three years<sup>2</sup></b></li> </ul>
UPDATED	Tanks And Piping Installed Or Replaced After April 11, 2016	<ul style="list-style-type: none"> <li><b>Secondary containment with interstitial monitoring</b></li> <li>Pressurized piping must also have an automatic line leak detector</li> <li>No requirements for suction piping (if the system has the characteristics described on page 19)</li> <li><b>Test containment sumps used for piping interstitial monitoring every three years<sup>2</sup></b></li> </ul>
UPDATED	Release Detection Testing Beginning October 13, 2018	<ul style="list-style-type: none"> <li><b>Annual release detection equipment operability testing</b></li> </ul>
UPDATED	Facilities Using Vapor Or Groundwater Monitoring	<ul style="list-style-type: none"> <li><b>No later than October 13, 2018, begin keeping a record of a site assessment for as long as the method is used</b></li> </ul>
<b>Walkthrough Inspections (pages 21-22)</b>		
UPDATED	All Facilities Beginning On October 13, 2018	<ul style="list-style-type: none"> <li><b>30 day and annual walkthrough inspections</b></li> </ul>
<b>Compatibility (pages 23-24)</b>		
UPDATED	All Facilities	<ul style="list-style-type: none"> <li>Use UST systems made of or lined with material compatible with the substance stored</li> <li><b>For systems storing certain regulated substances, maintain records demonstrating compliance with the compatibility requirement</b></li> </ul>
<b>Operator Training (page 25)</b>		
UPDATED	All Facilities Beginning On October 13, 2018	<ul style="list-style-type: none"> <li><b>Have designated and trained Class A, B, and C operators</b></li> </ul>
<b>Repairs (pages 26-27)</b>		
UPDATED	All Facilities	<ul style="list-style-type: none"> <li>Conduct testing following repairs to your tank, piping, or cathodic protection system</li> <li><b>Test or inspect components within 30 days after a repair to spill or overfill prevention equipment or secondary containment areas</b></li> </ul>
<b>Financial Responsibility (page 28)</b>		
	All Facilities	<ul style="list-style-type: none"> <li>Keep records demonstrating you have the financial resources to clean up a site if a release occurs, correct environmental damage, and compensate third parties for injury to their property or themselves</li> </ul>
<b>Release Response (pages 29-30)</b>		
	All Facilities	<ul style="list-style-type: none"> <li>Take corrective action in response to releases</li> </ul>
<b>Closure (pages 31-32)</b>		
	All Facilities	<ul style="list-style-type: none"> <li>Properly temporarily or permanently close your UST system</li> </ul>

Notes:

<sup>1</sup> Ball float valves may not be used when overfill prevention is installed or replaced after October 13, 2015.

<sup>2</sup> Spill containment and containment sump testing is not required if the containment is double-walled and uses periodic interstitial monitoring.

<sup>3</sup> USTs storing fuel for emergency power generation installed on or before October 13, 2015 must begin meeting the release detection requirements on October 13, 2018. USTs storing fuel for emergency power generation installed after October 13, 2015 must meet the release detection requirements at installation.

<sup>4</sup> Monthly monitoring (not to exceed 30 days) includes: interstitial monitoring; automatic tank gauging; vapor monitoring, groundwater monitoring; statistical inventory reconciliation; continuous in-tank leak detection; and other methods approved by your implementing agency.

<sup>5</sup> Tanks 2,000 gallons and smaller may be able to use manual tank gauging (page 18).

UPDATED

# What Must You Do When You Install An UST?



Make sure your UST system is installed correctly; use qualified installers who follow industry codes and manufacturers' instructions. (See [www.epa.gov/ust/underground-storage-tanks-usts-laws-regulations#code](http://www.epa.gov/ust/underground-storage-tanks-usts-laws-regulations#code) for more information on industry codes and installation practices.)

- Make sure the certification for proper installation on the notification form is completed and signed. You can find the notification form at [www.epa.gov/sites/production/files/2015-07/documents/updated-form.pdf](http://www.epa.gov/sites/production/files/2015-07/documents/updated-form.pdf).

Installation problems may result from installation practices that do not follow standard industry codes and procedures. Improper installation could result in UST system failures. Installation includes activities such as excavation, UST system siting, burial depth, tank system assembly, backfilling around the UST system, and surface grading.

Make sure that installers carefully follow the correct installation procedures called for by manufacturers' instructions and industry codes.

## What you must do for under-dispenser containment:

UPDATED

**Dispensers installed after April 11, 2016 must have under-dispenser containment. Under-dispenser containment must be liquid-tight on its sides, bottom, and at any penetrations. Under-dispenser containment must allow for visual inspection and access to the components in the containment system or be periodically monitored for leaks from the dispenser system.**

---

Mistakes can be made during installation. For example, mishandling of the tank during installation can cause issues with tanks, tank coatings, and cathodic protection. Improper layout of piping runs, incomplete tightening of joints, inadequate cover pad construction, and construction accidents can lead to failure of delivery piping.

---



Under-dispenser containment



# What Must You Report?



You must report to your implementing agency on the following occasions:

	When This Happens:	You Must Report This:	By This Time:
	After you install an UST	You must complete and submit a notification form available from your implementing agency. This form requests information about your UST, including a certification of correct installation. You should have already used this form to identify your existing USTs. If you have not done that yet, do so now.	Within 30 days of bringing the UST into use
UPDATED	After you acquire an UST, such as by purchasing a gas station	You must complete and submit a notification of ownership change form available from your implementing agency.	Within 30 days after you acquire an UST
UPDATED	Before switching to certain biofuels or other substances identified by your implementing agency	You must notify your implementing agency (page 23).	At least 30 days before switching to certain biofuels or other substances identified by your implementing agency
	When you suspect a release	You must report suspected releases to your implementing agency (page 29).	Within 24 hours (or another period specified by your implementing agency)
	When you confirm a release	You must report follow-up actions you plan or have taken to correct the damage caused by your UST (page 30).	Within 20 days (or another period specified by your implementing agency)
	Before you permanently close your UST	You must notify your implementing agency (page 32).	At least 30 days before you permanently close your UST

Check with your implementing agency for additional requirements not noted above.

# What Are Your Spill And Overfill Prevention Requirements?



## What you must do for spill prevention:

- Your USTs must have spill prevention equipment (commonly called spill buckets or catchment basins) to contain drips and small spills that can occur when the delivery hose is disconnected from the fill pipe.
- **You must test your spill prevention equipment at least every three years for liquid tightness or use a double-walled spill bucket with periodic interstitial monitoring. The test must be conducted according to a code of practice or manufacturer's instructions.**
- **No later than October 13, 2018, you must begin inspecting your spill prevention equipment at least every 30 days (or before each delivery if you receive deliveries less frequently than every 30 days). See page 21 for more information about what you must check during your walkthrough inspections.**
- You and your delivery person must follow correct filling practices.

UPDATED

UPDATED

Many releases at UST sites come from spills. Spills often occur at the fill pipe when the delivery truck's hose is disconnected. Although these spills are usually small, repeated small releases can cause big environmental problems.

### **What Are Spill Buckets?**

Spill buckets are also called spill containment manholes or catchment basins. Basically, a spill bucket is a contained area around the fill pipe.

To protect against spills, the spill bucket should be large enough to contain what may spill when the delivery hose is uncoupled from the fill pipe. Spill buckets range in size from those capable of holding only a few gallons to those that are much larger – the larger the spill bucket, the more spill protection it provides.

---

If an UST never receives more than 25 gallons at a time, the UST does not have to meet the spill prevention requirements. Many small used oil tanks fall in this category.

---

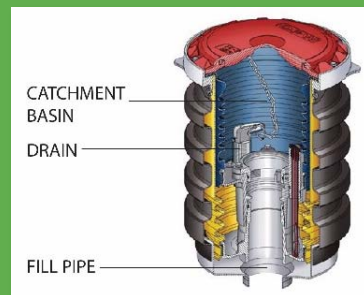

Spill bucket

---

Sloping the surrounding surface away from the tops of spill buckets helps keep water out of them.

---

You should try to keep water out of spill buckets. Some spill buckets can collect water and sediment, along with spilled product, making draining this mixture into the tank unwise. If this happens, you may pump out the spill bucket and dispose of the liquid properly. If the liquid contains fuel or chemicals, it could be considered a hazardous waste. Contact your implementing agency responsible for hazardous waste for information on testing and handling requirements.

*Your equipment supplier can help you choose the size and type of spill bucket that meets your needs.*

### What you must do for overfill prevention:

UPDATED

- Your UST must have overfill prevention. **Automatic shutoff devices, overfill alarms, and ball float valves are the three types of overfill prevention devices, which are described below.**
- **You must inspect your overfill prevention equipment at least once every three years to ensure it will function properly to prevent overfills. The inspection must be conducted according to a code of practice or manufacturer's instructions.**
- You and your delivery person must follow correct filling practices.

UPDATED

*To work properly, all overfill devices must be installed correctly at the proper distance below the tank top as specified by the manufacturer.*

Overfills usually release much larger volumes than spills. When a tank is overfilled, large volumes can be released at the fill pipe and at other areas of the UST system, such as loose fittings on the top of the tank, vapor recovery ports, a loose vent pipe, or other tank top openings.

You can solve overfill problems by:

- Making sure there is enough room in the tank for the delivery before the delivery is made;
- Watching the entire delivery to prevent overfilling or spilling; and
- Using overfill prevention devices.

*If an UST never receives more than 25 gallons at a time, the UST does not have to meet the overfill prevention requirements. Many small used oil tanks fall in this category.*

*Note:* If you receive pumped deliveries, which means fuel is delivered under pressure, you must make sure your overfill prevention device works properly with pumped deliveries. Also, remember that overfill prevention devices are effective only when combined with careful filling practices.

### What Are Automatic Shutoff Devices?

An automatic shutoff device installed in an UST's fill pipe slows down and then stops delivery no later than when the product reaches 95 percent capacity or before the fittings on top of the tank are exposed to product. This device – sometimes called a flapper

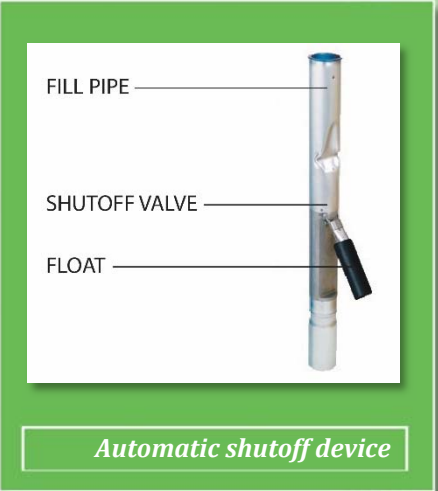

*Automatic shutoff device*

valve – has one or two valves that are operated by a float mechanism.

Some automatic shutoff devices work in two stages. The first stage drastically reduces the flow of product to alert the delivery person that the tank is nearly full. The delivery person can then close the delivery valve and still have room in the tank for the product left in the delivery hose.

If the delivery person does not pay attention and the liquid level rises higher, the valve closes completely and no more liquid can be delivered into the tank, leaving the delivery person with a delivery hose full of product.

### **What Are Overfill Alarms?**

Overfill alarms use probes installed in the tank to activate an alarm no later than when the tank is either 90 percent full or within 1 minute of being overfilled. Either way, the alarm should provide enough time for the delivery person to close the truck's shutoff valve before an overfill happens. Alarms must be located where the delivery person can see or hear them easily. Overfill alarms are often part of automatic tank gauging systems.

Overfill alarms work only if they alert the delivery person at the right time and the delivery person responds quickly. Remember to put the alarm on an electrical circuit that is active all the time so that the alarm will always work. Many deliveries are made at night when the facility is closed. You do not want to turn off your alarm when you turn off the lights.

### **What Are Ball Float Valves?**

In addition to the two types of overfill prevention described above, ball float valves may be used on tanks installed on or before October 13, 2015 as long as the ball float valve continues to operate properly. If the ball float valve must be replaced, owners and operators must use either an automatic shutoff device or overfill alarm. **Ball float valves may not be used when overfill prevention is installed or replaced after October 13, 2015.**

Flow restrictors in vent lines, also called ball float valves, are placed at the bottom of the vent line several inches below the top of the UST. The ball floats on the product and rises with product level during delivery until it restricts vapor flowing out the vent line *before* the tank is full. Ball float valves must begin restricting flow no later than when the tank reaches 90 percent of its capacity, or 30 minutes before overfilling. If all tank fittings are tight, the ball float valve can create enough back pressure to restrict product flow into the tank – this can notify the delivery person to close the truck's shutoff valve. However, if the UST has loose fittings,

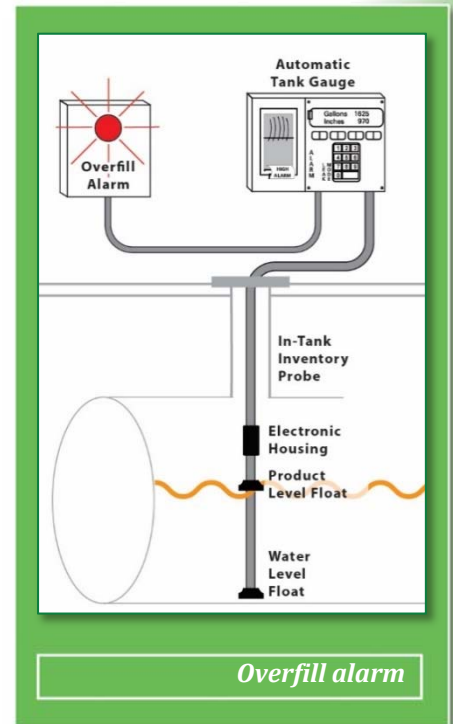

UPDATED



sufficient back pressure may not develop and could result in an overflow.

*Note:* Manufacturers do not recommend using ball float valves with suction piping, pressurized delivery, or coaxial Stage I vapor recovery.

UPDATED

**You must conduct your first ball float valve inspection no later than October 13, 2018. If the ball float valve is not operating properly and cannot be repaired, the overflow device must be replaced with either an automatic shutoff device or overflow alarm.**

## What Are Your Responsibilities For Correct Filling Practices?

Human error causes most spills. You can avoid these mistakes by following correct tank filling practices. For example, you must make sure there is room in the UST for the delivery, and the delivery person must watch the delivery at all times. For this reason, the federal UST regulation requires that you follow correct filling practices.

As an owner or operator, you are responsible for ensuring that releases due to spilling or overflowing do not occur during fuel delivery. As part of this responsibility, you must:

- Ensure the amount of product to be delivered will fit into the available empty space in the tank; and
- Ensure the transfer operation is monitored constantly to prevent overflowing and spilling.

### What To Do Before Your USTs Are Filled

- Post clear signs that alert the delivery person to the overflow devices and alarms in use at your facility.
- Make and record accurate readings for product and water in the tank before fuel delivery.
- Order only the quantity of fuel that will fit into 90 percent of the tank.
- The formula for determining the maximum amount of fuel to order is:  
(Tank capacity in gallons x 90%) – Fuel currently in tank  
= Maximum amount of fuel to order
  - Example: (10,000 gal. x 0.9) – 2,000 gal. = 7,000 gal. maximum amount to order
- Ensure the delivery person knows the type of overflow device present at the tank and what actions to perform if it activates.
- Review and understand the spill response procedures.

*If you and your delivery person follow correct filling practices, nearly all spills and overfills can be prevented.*



- Verify that your spill bucket is empty, clean, and will contain spills.

### ***What To Do While Your USTs Are Being Filled***

- Keep fill ports locked until the delivery person requests access.
- Keep an accurate tank capacity chart available for the delivery person.
- The delivery person makes all hook-ups.
- The person responsible for monitoring the delivery should remain attentive and observe the entire fuel delivery; be prepared to stop the flow of fuel from the truck to the UST at any time; and respond to any unusual condition, leak, or spill that may occur during delivery.
- Keep response supplies readily available for use in case a spill or overfill occurs.
- Provide safety barriers around the fueling zone.
- Make sure there is adequate lighting around the fueling zone.



### ***What To Do After Your USTs Are Filled***

- Following complete delivery, the delivery person is responsible for disconnecting all hook-ups.
- Return spill response kit and safety barriers to proper storage locations.
- Make and record accurate readings for product and water in the tank after fuel delivery.
- Verify the amount of fuel received.
- Make sure fill ports are properly secured.
- Ensure the spill bucket is free of product and clean up any small spills.

# What Are Your Corrosion Protection Requirements?



The federal UST regulation requires corrosion protection to help prevent your USTs from releasing product into the environment.

Tanks and piping entirely made of non-corrodible material, such as fiberglass, do not need cathodic protection.

## What Are Cathodic Protection Methods?

*Sacrificial Anode System:* Sacrificial anodes are buried and attached to UST components for corrosion protection. Anodes are pieces of metal that are more electrically active than steel, and thus they suffer the destructive effects of corrosion rather than the steel they are attached to.

*Impressed Current System:* An impressed current system uses a rectifier to provide direct current through anodes to the tank or piping to achieve corrosion protection. The steel is protected because the current going to the steel overcomes the corrosion-causing current flowing away from it. The cathodic protection rectifier must always be on and operating to protect your UST system from corrosion.

You must have a qualified cathodic protection tester periodically test your cathodic protection system to make sure the cathodic protection system is protecting the UST system. If you have an impressed current system, you must inspect it at least once every 60 days to make sure the impressed current rectifier is running properly.

Never turn off your rectifier. If your rectifier is off, your UST system is not being protected from corrosion.

Corrosion results when bare metal and soil and moisture conditions combine to produce an underground electric current that destroys hard metal. Over time, unprotected USTs can corrode and leak.

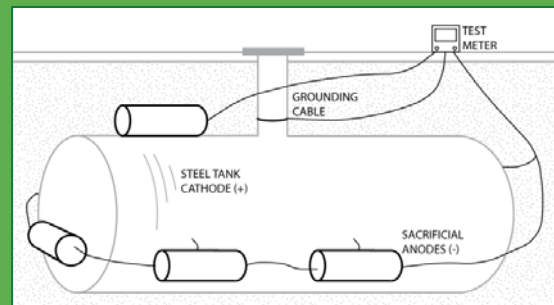

Sacrificial anode system

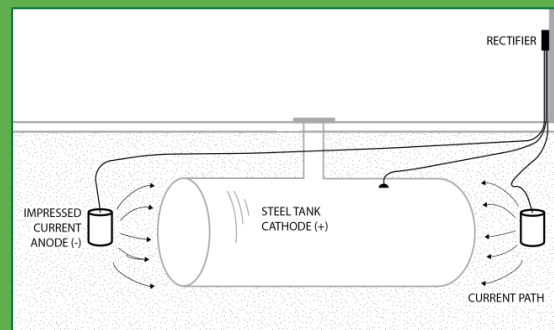

Impressed current system

## Corrosion Protection For Steel USTs Installed On Or Before December 22, 1988

Steel tanks installed on or before December 22, 1988, must either have been assessed and upgraded with corrosion protection using *one* of the following *three* methods or meet the corrosion protection requirements for tanks installed after December 22, 1988:

- *Added cathodic protection.* The cathodic protection system must have been tested by a qualified cathodic protection tester within six months of installation and at least once every three years thereafter. You must keep the results of the last two tests to prove that the cathodic protection is working. In addition, if you have an impressed current cathodic protection system, you must inspect it at least once every 60 days to verify that the system is operating. Keep results of your last three inspections to prove that the impressed current system is operating properly.
- *Added interior lining to the tank.* The interior of a tank could have been lined with a thick layer of noncorrodible material (see [www.epa.gov/ust/underground-storage-tanks-usts-laws-regulations#code](http://www.epa.gov/ust/underground-storage-tanks-usts-laws-regulations#code) for industry codes). Tanks using only an interior lining for corrosion protection must have passed an internal lining inspection within 10 years of installation of the internal lining and every five years after that to make sure that the lining is sound. Keep records of the inspection results.
- *Combined cathodic protection and interior lining.* You could have added both cathodic protection and interior lining. This combined method does not require you to have the interior lining periodically inspected if your tank was assessed and found to be structurally sound and free of corrosion holes when you added cathodic protection. You still must have the cathodic protection system periodically tested and inspected and keep records as explained in the first bullet point above.

*Note that field installed cathodic protection must be designed by a corrosion expert.*

*Only tanks that were proven to be structurally sound could have been lined.*

## Corrosion Protection For Metal Piping Installed On Or Before December 22, 1988

Metal piping installed on or before December 22, 1988 must have cathodic protection. In addition, owners and operators must test, inspect, and keep records as described above for tank cathodic protection.



## Corrosion Protection For Steel Tanks And Piping Installed After December 22, 1988

Your tanks and piping must meet one of the following to be protected from corrosion:

- Tank and piping are completely made of a noncorrodible material, such as fiberglass.
- Tank is made of steel and completely isolated from contact with the surrounding soil by being enclosed or jacketed in noncorrodible material. This option does not apply to piping.
- Tank and piping are made of steel having a corrosion-resistant coating and having cathodic protection, such as an sti-P3® tank with appropriate piping. A corrosion-resistant coating electrically isolates the coated metal from the surrounding environment to help protect against corrosion. An asphaltic coating does not qualify as a corrosion-resistant coating. Galvanized steel does not meet the corrosion protection requirements. You must have cathodic protection systems tested and inspected and keep records as explained in the first bullet point on the previous page.

# What Are Your Release Detection Requirements?



You must provide your UST system with release detection that allows you to meet the following basic requirements:

- You can detect a release from any portion of the tank or its piping that routinely contains product;
- Your release detection is installed and calibrated according to the manufacturer's instructions; and
- Your release detection meets the performance requirements described in the federal UST regulation. See 40 CFR 280.43 and 280.44.

For more information about release detection methods and requirements please see EPA's *Release Detection For Underground Storage Tanks And Piping: Straight Talk On Tanks*.

UPDATED

**No later than October 13, 2018, you must perform your first annual release detection equipment test to make sure components such as probes, sensors, and automatic line leak detectors are working properly. You must keep records of these tests for three years.**

UPDATED

**No later than October 13, 2018, you must begin conducting walkthrough inspections that check your release detection equipment every 30 days. In addition, you must check your hand-held release detection equipment annually. You must keep records of the walkthrough inspection for one year. See pages 21-22 for more information about what you must do on your walkthrough inspections.**

UPDATED

**Piping Replacements: After April 11, 2016, if you repair 50 percent or more of your piping in a single piping run, that piping must be replaced.** This means you must remove the entire piping run and install secondarily contained piping. You must also use interstitial monitoring for release detection. For pressurized piping, a piping run is all piping that connects the submersible turbine pump to all of the dispensers fed by that pump. For suction piping, a piping run is the piping that runs between the tank and the suction pump.

---

If you replace 50 percent or more of your piping after April 11, 2016, the entire piping run must be secondarily contained and use interstitial monitoring for release detection.

---

---

Remember your emergency generator USTs. These UST systems must be secondarily contained and use interstitial monitoring if installed after April 11, 2016.

---

USTs storing fuel for emergency power generators must begin meeting the release detection requirements. For emergency generator UST systems installed on or before October 13, 2015, you must begin meeting the release detection requirements by October 13, 2018 using one of the methods described below. For emergency generator UST systems installed after October 13, 2015 but on or before April 11, 2016, you must begin meeting the release detection requirements at installation by using one of the methods described below. Emergency generator UST systems installed after April 11, 2016 must be secondarily contained and use interstitial monitoring upon installation.

### Release detection requirements for tanks installed on or before April 11, 2016:

Below we list the monthly monitoring methods you may use to meet the federal release detection requirements. As temporary methods, you may instead use inventory control combined with tank tightness testing, or manual tank gauging combined with tank tightness testing, as described on pages 17-18. See additional release detection requirements for piping on pages 18-20.

*This booklet sometimes uses the term monthly as it applies to release detection monitoring frequency. This term means release detection monitoring must occur at least once every 30 days.*

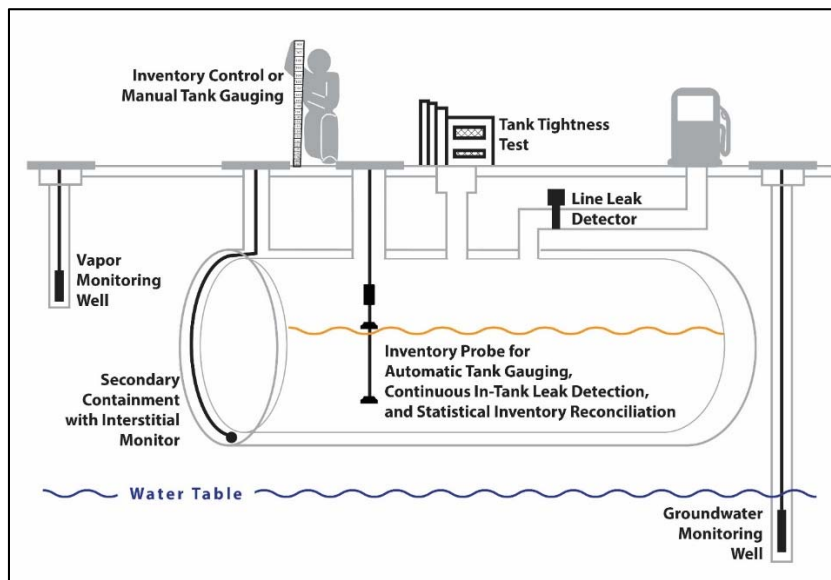

#### Monthly Monitoring Methods

- *Interstitial monitoring:* This method detects leaks in the space between the primary wall and a secondary barrier of the tank. The federal UST regulation describes general performance requirements for interstitial monitoring with double-walled USTs, USTs fitted with internal liners, and USTs using secondary barriers.

*Release detection for USTs installed on or before April 11, 2016 may consist of one or a combination of the release detection methods listed on pages 16-18.*

- *Automatic tank gauging (ATG) systems*: This method uses automated processes to monitor product level and perform inventory control.
- *Continuous in-tank leak detection (CITLD)*: This method encompasses all statistically based methods where the system incrementally gathers measurements on an uninterrupted or nearly uninterrupted basis to determine a tank's release status. This method typically uses sensors permanently installed in the tank to obtain inventory measurements, combined with a microprocessor in the ATG system or other control console that processes the data.
- *Statistical inventory reconciliation (SIR)*: For this method, typically a trained professional uses sophisticated computer software to conduct a statistical analysis of inventory, delivery, and dispensing data, which you must supply regularly.
- *Groundwater monitoring*: This method monitors the groundwater table near an UST for the presence of released free product on the water table. Monitoring wells near the UST are checked frequently to see if petroleum can be detected. The federal UST regulation describes several requirements for using this method. For example, you cannot use this method if the water table is more than 20 feet below the surface of the ground.
- *Vapor monitoring*: This method samples for petroleum hydrocarbon vapors (sometimes called passive monitoring) or tracer compound vapors (sometimes called active monitoring) in the soil surrounding the UST. Released petroleum produces vapors that can be detected in the soil. The federal UST regulation describes several requirements for using vapor monitoring. For example, this method requires that the stored substance can migrate through a porous backfill material so that it can be detected within 30 days. A site assessment must be conducted prior to using the method to ensure site conditions meet the requirements.
- *Other methods*: Methods that can detect a 0.2 gallon per hour leak rate or 150 gallons within a month that meet performance standards of a 95 percent probability of detection and no more than a 5 percent probability of false alarm may also be used. In addition, other methods approved by your implementing agency that can be shown to work as effectively as the methods described above for release detection may be used.

*Starting on October 13, 2018, if you use vapor monitoring or groundwater monitoring, you must keep records of a site assessment for as long as you use these methods showing that the monitoring system is set up properly. If you do not have a site assessment for your vapor monitoring or groundwater monitoring, you will need to have one conducted. Site assessments conducted after October 13, 2015 have to be signed by a licensed professional.*

### ***Alternate Release Detection Method Allowed For Up To 10 Years After Installation***

For USTs installed on or before April 11, 2016, instead of using one of the monthly monitoring methods noted above, you can combine inventory control with tank tightness testing, but only for



10 years after you installed the tank. Inventory control involves taking daily measurements of tank contents and recording deliveries and amount pumped. Based on daily and monthly calculations, you can discover if your tank may be leaking.

Tank tightness testing usually requires taking the UST out of service while changes in level or volume over time are measured. Your UST will need a tank tightness test every five years. After 10 years, you must use one of the monthly monitoring methods.

The success of this temporary combined method depends on your performing inventory control correctly. See EPA's booklet, *Doing Inventory Control Right*, which clearly explains how to do inventory control with simple step-by-step directions [www.epa.gov/ust/doing-inventory-control-right-underground-storage-tanks](http://www.epa.gov/ust/doing-inventory-control-right-underground-storage-tanks). The booklet includes example forms for recording inventory data.

### **Additional Release Detection Method For Small Tanks**

Tanks of 2,000 gallons capacity or less that were installed on or before April 11, 2016 may be able to use manual tank gauging as a release detection method, either by itself or in combination with tank tightness testing. This method involves keeping the tank undisturbed for at least 36-58 hours each week, during which the tank's contents are measured, twice at the beginning and twice at the end of the test period. Manual tank gauging can be used without tightness testing for tanks with a capacity of 550 gallons or less and for tanks with capacities between 551 gallons and 1,000 gallons with a diameter of either 48 inches or 64 inches.

All other tanks using manual tank gauging must combine the method with tank tightness testing. These tanks may only use the combined method for up to 10 years after installation.

See EPA's booklet, *Manual Tank Gauging For Small Underground Storage Tanks*, which explains how to do manual tank gauging with simple step-by-step directions [www.epa.gov/ust/manual-tank-gauging-small-underground-storage-tanks](http://www.epa.gov/ust/manual-tank-gauging-small-underground-storage-tanks). The booklet includes standard forms for recording inventory data.

### **Release detection requirements for piping installed on or before April 11, 2016:**

Pressurized piping installed on or before April 11, 2016 must meet these requirements:

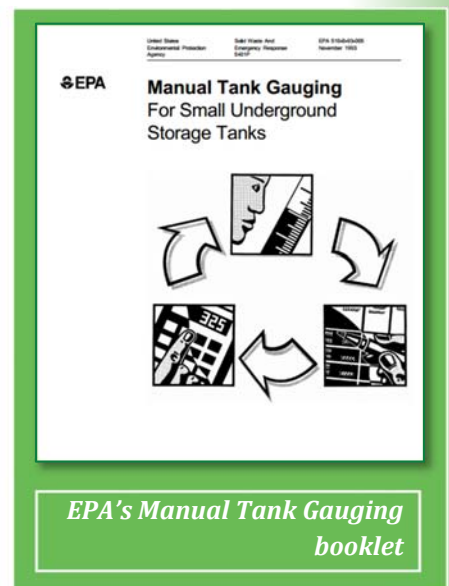
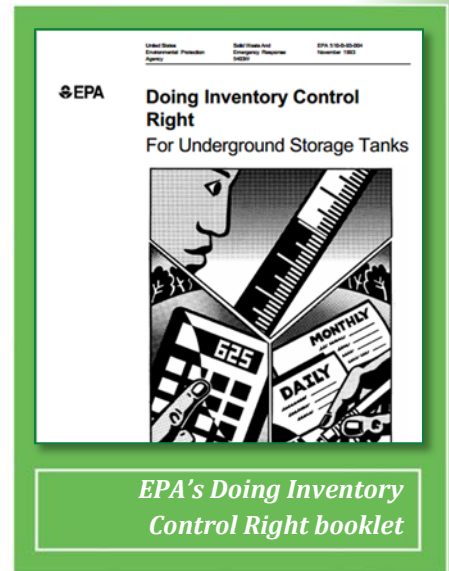

- The piping must have an automatic line leak detector that will stop or restrict flow, or activate an alarm when a release is detected.
- You must either conduct an annual tightness test of the piping or use one of these monthly methods that apply to piping: interstitial monitoring, vapor monitoring, groundwater monitoring, statistical inventory reconciliation, continuous in-tank leak detection, or other approved monthly methods.

If your UST has suction piping, your release detection requirements will depend on which type of suction piping you have. No release detection is required if the suction piping system has:

- Below-grade piping that operates under atmospheric pressure;
- Enough slope so that the product in the pipe can drain back into the tank when suction is released; and
- Only one check valve, which is as close as possible beneath the pump in the dispensing unit.

If suction piping is to be considered exempt based on these design elements, there must be some way to verify that the piping was installed according to these criteria.

Suction piping installed on or before April 11, 2016 that does not meet all of the design criteria noted above must have release detection (either monthly monitoring using one of the monthly methods noted above for use on pressurized piping or tightness testing of the piping every three years).

### **Release detection requirements for tanks and piping installed after April 11, 2016:**

UPDATED

**Tanks and piping installed after April 11, 2016 must have secondary containment and interstitial monitoring.** Interstitial monitoring detects leaks in the space between the primary wall of the tank or pipe and a secondary barrier. The regulation describes general performance requirements for interstitial monitoring with double-walled USTs, USTs fitted with internal liners, and USTs using secondary barriers.

#### ***Additional Release Detection For Piping***

Pressurized piping must have an automatic line leak detector that will stop or restrict flow, or activate an alarm when a release is detected.

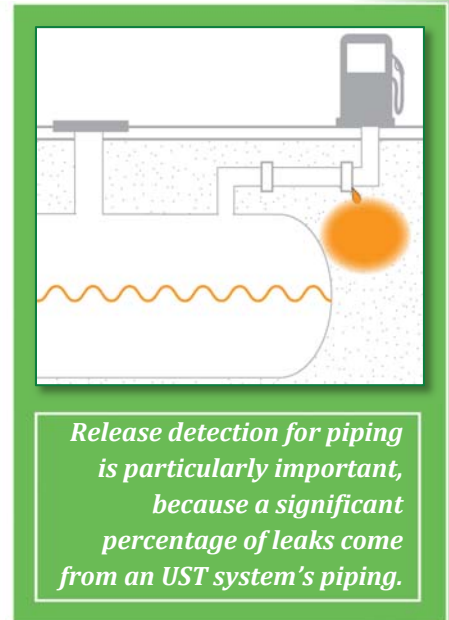

If your UST has suction piping, your release detection requirements will depend on which type of suction piping you have. No release detection is required if the suction piping system meets the requirements on page 19.

If suction piping is to be considered exempt based on these design elements, there must be some way to verify that the piping was actually installed according to these criteria.

Suction piping installed after April 11, 2016 that does not meet all of the design criteria listed on page 19 must use interstitial monitoring.

### **What you must do for containment sumps:**

**UPDATED**

**No later than October 13, 2018, you must perform your first three year containment sump test for liquid tightness on sumps used for interstitial monitoring of piping or use double-walled containment sumps with periodic interstitial monitoring of the space between the two walls of the sump.**

# What Must You Do For Walkthrough Inspections?



UPDATED

No later than October 13, 2018, you must begin conducting periodic walkthrough inspections to make sure your equipment is working properly and catch problems early. Walkthrough inspections must cover:

Every 30 days:

- **Spill prevention equipment**
  - Visually check for damage.
  - Remove liquid or debris.
  - Check for and remove obstructions in the fill pipe.
  - Check the fill cap to make sure it is securely on the fill pipe.
  - For double-walled spill prevention equipment with interstitial monitoring, check for a leak in the interstitial area.
  - For tanks that receive deliveries less frequently than every 30 days, the spill prevention equipment inspection may be conducted before each delivery.
- **Release detection equipment**
  - Check to make sure the release detection equipment is operating with no alarms or other unusual operating conditions present.
  - Ensure release detection records are reviewed and current.
  - Owners and operators who monitor their release detection systems remotely may check the release detection equipment and records remotely, as long as the release detection systems at the locations are determined to be in communication with remote monitoring equipment.

---

You must conduct your first monthly and annual walkthrough inspection no later than October 13, 2018.

---



Inspecting a containment sump

**Annually:**

- **Containment sumps**
  - **Visually check for damage, leaks to the containment area, and releases to the environment.**
  - **Remove liquid from containment sumps.**
  - **Remove debris.**
  - **For double-walled sumps with interstitial monitoring, check for leaks in the interstitial area.**
- **Hand-held release detection equipment**
  - **Check devices such as tank gauge sticks or groundwater bailers for operability and serviceability.**

**You can also conduct walkthrough inspections according to a standard code of practice developed by a nationally-recognized association or independent testing laboratory or according to requirements developed by your implementing agency, if the code of practice checks equipment in a manner comparable to the requirements above.**

**You may perform walkthrough inspections yourself or have a third party conduct them.**

**You must keep records of your walkthrough inspections for one year.**



# Compatibility With Biofuels And Other Regulated Substances



Since 1988, EPA has required UST systems to be compatible with the substance stored in them. As newer fuels with different chemical properties enter the marketplace, it is even more important for you to make sure your UST system is compatible with the fuel stored in your system. Compatibility is the ability of two or more substances (in this case, your UST system and the regulated substance stored) to maintain their respective physical and chemical properties when in contact with one another. Compatibility is required for the design life of the UST system and under conditions likely to be encountered by the UST.

Make sure your UST system is compatible with the substance it stores.

UPDATED

**In addition to the original compatibility requirement, you must meet these requirements.**

**You must notify your implementing agency at least 30 days before switching to any of these products:**

- **Regulated substances containing greater than 10 percent ethanol.**
- **Regulated substances containing greater than 20 percent biodiesel.**
- **Any other regulated substance identified by your implementing agency.**

**In addition, you must meet specific requirements when storing these fuels. You may either demonstrate you are using equipment or components approved for use with the regulated substance stored, or use another option determined by your implementing agency to be no less protective of human health and the environment than the compatibility demonstration options listed below. Ways to demonstrate compatibility include having the following documentation:**

- **Certification or listing of the equipment or component by a nationally recognized, independent testing laboratory for use with the regulated substance stored; or**

- **Written statement from the manufacturer affirming the equipment or component is compatible with the regulated substance stored.**

**As long as you store regulated substances containing greater than 10 percent ethanol, greater than 20 percent biodiesel, or any other regulated substance identified by your implementing agency, you must keep records demonstrating compliance with the compatibility requirement.**

# What Are The Operator Training Requirements?



UPDATED

No later than October 13, 2018, you must have designated Class A, B, and C operators and trained them on their UST responsibilities. There are three classes of operators, each with different responsibilities:

- **Class A operator is the person who has primary responsibility to operate and maintain the UST system according to the UST regulation. Class A operator training provides a general knowledge of the UST regulation.**
- **Class B operator is the person who has day-to-day responsibility for implementing the UST regulation. Class B operator training provides a more in-depth understanding of operation and maintenance aspects of UST systems.**
- **Class C operator is any person responsible for the immediate response to a problem at an UST facility, such as a gas station attendant. Class C operator training must cover how to respond to an alarm or emergency.**

A single individual may be designated as more than one class of operator, as long as that individual is trained in all responsibilities for each class of operator designated.

Operators may need to be retrained if the UST system is not in compliance.

You must keep a list of currently designated operators trained for each facility and proof of training or retraining for each operator. You may keep the records off site.

Most states already have their own operator training program. Contact your implementing agency for information specific to the state where your USTs are located.

---

For more information about your state's operator training program, contact your implementing agency. See a list of contacts at [www.epa.gov/ust-underground-storage-tank-ust-contacts#states](http://www.epa.gov/ust-underground-storage-tank-ust-contacts#states).

---

# How Do You Repair UST Systems?



## Can Leaking Tanks Be Repaired?

You can repair a tank if the person who repairs the tank carefully follows standard industry codes that establish the correct way to conduct repairs. See [www.epa.gov/ust/underground-storage-tanks-usts-laws-regulations#code](http://www.epa.gov/ust/underground-storage-tanks-usts-laws-regulations#code) for industry codes and standards.

Within 30 days of the repair, you must prove that the tank is repaired by:

- Having the tank inspected internally or tightness tested following standard industry codes; or
- Using one of the monthly release detection monitoring methods on pages 16-17; or
- Using other methods approved by your implementing agency.

UPDATED

**Within 30 days after repairs to secondary containment areas of tanks, you must have the secondary containment tested for tightness.**

UPDATED

**Within 30 days after repairs to spill or overfill prevention equipment, you must test or inspect the repaired spill or overfill prevention equipment, as appropriate, to ensure it is operating properly.**

Within six months of repair, USTs with cathodic protection must be tested to show that the cathodic protection is working properly.

## Can Leaking Piping Be Repaired?

Damaged metal piping cannot be repaired and must be replaced. Loose fittings can be tightened, and in some cases that may solve the leaks.

Piping made of fiberglass-reinforced plastic can be repaired, but only according to the manufacturer's instructions or national codes of practice. Within 30 days of the repair, piping must be tested in the same ways noted above for testing tank repairs, except for internal inspection.

---

Replace damaged metal piping; do not repair it.

---

UPDATED

**Within 30 days after repairs to secondary containment areas of piping used for interstitial monitoring and to containment sumps used for interstitial monitoring of piping, you must have the secondary containment tested for tightness.**

UPDATED

**After April 11, 2016, when 50 percent or more of the piping connected to a single tank is removed and replaced, the entire piping run must be replaced with piping that has secondary containment and interstitial monitoring.**

### **What Records Must You Keep?**

You must keep records for each repair until the UST is permanently closed or undergoes a change-in-service.



# Financial Responsibility



You must maintain documentation showing you have the financial resources to clean up your UST site if a release occurs, correct environmental damage, and compensate third parties for injury to their properties or themselves. The amount of coverage depends on the type and size of your business, as summarized in the chart below.

Group Of UST Owners And Operators	Per Occurrence Coverage	Aggregate Coverage
Petroleum marketers or owners and operators who handle more than 10,000 gallons per month	\$1 million	\$1 million if you have 100 or fewer USTs  or \$2 million if you have more than 100 USTs
All others	\$500,000	

You have several options to demonstrate financial responsibility. These include:

- Obtain insurance coverage from an insurer or a risk retention group;
- Use a financial test to demonstrate self-insurance; obtain corporate guarantees, surety bonds, or letters of credit;
- Place the required amount into a trust fund administered by a third party; or
- Rely on coverage provided by a state financial assurance fund.

Local governments also have four additional options tailored to their specific characteristics: a bond rating test, a financial test, a guarantee, and a dedicated fund.

EPA's booklet, *Dollars And Sense*, briefly summarizes the financial responsibility requirements.

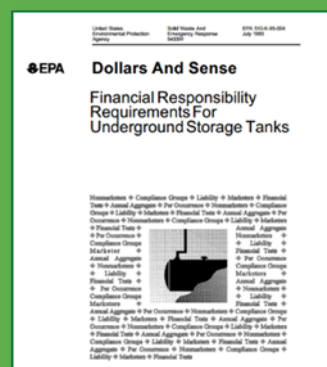

EPA's *Dollars And Sense*:  
[www.epa.gov/ust/dollars-and-sense-financial-responsibility-requirements-underground-storage-tanks](http://www.epa.gov/ust/dollars-and-sense-financial-responsibility-requirements-underground-storage-tanks)

# What Must You Do About UST Releases?



Warning signals indicate that your UST may be leaking and creating problems for the environment and your business. You can minimize these problems by paying careful attention to early warning signals and reacting quickly before major problems develop.

You should suspect a release when you observe these warning signals:

- Unusual operating conditions. Check first to see if the problem results from equipment failure that can be repaired. Remember to remove any liquid not used for interstitial monitoring from the interstitial space of secondarily contained systems.
- Results from release detection monitoring and testing that indicate a release. What at first appears to be a release may be the result of faulty equipment that is part of your UST system or its release detection. Check this equipment carefully for failures.

If you investigate an unusual operating condition or release detection alarm and determine a release has not occurred, you do not need to report a suspected release as long as you immediately fix the problem. Otherwise, you need to call your implementing agency and report the suspected release. Then find out quickly if the suspected release is an actual release. Use these investigative steps:

UPDATED

- Conduct tightness testing or **interstitial integrity testing of the entire UST system.**
- Check the site for additional information on the presence and source of contamination.

If the system tests and site checks confirm that a release has occurred, follow the actions for responding to confirmed releases described below.

You must also respond quickly to any evidence of released petroleum that appears at or near your site. For example, neighbors might tell you they smell petroleum vapors in their basements or taste petroleum in their drinking water. If evidence of this type is discovered, you must report this

---

Unusual operating conditions include such things as erratic behavior of the dispensing pump and unexplained liquid in the interstitial space of secondarily contained systems.

---

discovery immediately to your implementing agency and take the investigative steps and follow-up actions noted above.

Your action to confirmed releases comes in two stages: short term and long term.

### **Short-Term Actions**

- Take immediate action to stop and contain the release.
- Report the release to your implementing agency within 24 hours or the time frame required by your implementing agency. However, petroleum spills and overfills of less than 25 gallons do not have to be reported if you immediately contain and clean up these releases.
- Make sure the release poses no immediate hazard to human health and safety by removing explosive vapors and fire hazards. Your fire department should be able to help or advise you with this task. You must also make sure you handle contaminated soil properly so that it poses no hazard, for example, from vapors or direct contact.
- If necessary, remove petroleum from the UST system to prevent further release into the environment.
- Find out how far the petroleum has moved and begin to recover the released petroleum, such as product floating on the water table. Report your progress and any information you collect to your implementing agency no later than 20 days after confirming a release.
- Investigate to determine if the release has damaged or might damage the environment. This investigation must determine the extent of contamination both in soils and groundwater. You must report to your implementing agency what you have learned from an investigation of your site according to the schedule established by your implementing agency. At the same time, you must also submit a report explaining how you plan to clean up the site. Additional site studies may be required.

*Contact your implementing agency for guidance on doing site assessments and corrective action.*

### **Long-Term Actions**

Based on the information you provide, your implementing agency will decide if you must take further action at your site. You may need to take two more actions:

- Develop and submit a corrective action plan that shows how you will meet requirements established for your site by your implementing agency.
- Make sure you implement the actions approved by your implementing agency for your site.

# How Do You Close USTs?



You may close your UST temporarily or permanently.

## Closing Temporarily

You may temporarily close your UST by following these requirements:

- Continue to maintain and monitor corrosion protection systems
- Continue to maintain financial responsibility
- **No later than October 13, 2018, your operators must be trained**
- If your temporarily closed UST is not empty, you must also:
  - Continue to monitor for leaks by performing release detection.
  - **Begin performing monthly walkthrough inspections for your release detection no later than October 13, 2018.**
  - **Begin performing annual inspections and tests of release detection equipment no later than October 13, 2018.**
  - **Begin performing three year containment sump testing if using the containment sump for interstitial monitoring of the piping no later than October 13, 2018.**
- If a release is discovered, quickly stop the release, notify your implementing agency, and take appropriate action to clean up the site.
- If the UST remains temporarily closed for more than three months, leave vent lines open, but cap and secure all other lines, pumps, manways, and ancillary equipment.

UPDATED

UPDATED

UPDATED

UPDATED

USTs in temporary closure are not required to meet the following requirements:

- Spill prevention equipment and periodic testing.
- Overfill prevention equipment and periodic inspections.
- Empty USTs do not require:

---

Facilities with USTs in temporary closure must have trained operators beginning on October 13, 2018.

---

---

Note that some implementing agencies require removal of the regulated substance from the tank while in temporary closure. Other implementing agencies may require permanent closure after one year.

---

- Release detection.
- Annual release detection testing and inspections.
- Monthly walkthrough inspections.
- Three year containment sump testing.

An UST is considered empty if no more than one inch of residue is present or not more than 0.3 percent by weight of the total capacity of the UST system remains in the system.

After 12 months of temporary closure, you must permanently close your UST if the tank does not meet the corrosion protection requirements. You can indefinitely keep your UST closed temporarily, if it meets the requirements for new or upgraded USTs, except that spill and overfill requirements do not have to be met, and you meet the requirements above for temporarily closed USTs.

## Closing Permanently

If you decide for any reason to close your UST permanently, follow these requirements for permanent closure:

- You must notify your implementing agency 30 days before you permanently close your UST.
- You must determine if contamination from your UST is present in the surrounding environment. If there is contamination, you will have to take the actions described on pages 29-30.
- You can either remove the UST from the ground or leave it in the ground. In both cases, the tank must be emptied and cleaned by removing all liquids, dangerous vapor levels, and accumulated sludge. These potentially very hazardous actions need to be carried out carefully by following standard safety practices. See [www.epa.gov/ust/resources-owners-and-operators#closing](http://www.epa.gov/ust/resources-owners-and-operators#closing) for a safe closure standard. If you leave the UST in the ground, you must also either fill it with a harmless, chemically inactive solid, like sand or cement, **or close it in place in a manner approved by your implementing agency.** Your implementing agency can help you decide how best to close your UST so that it meets local requirements for closure.

UPDATED

*USTs in temporary closure do not need spill or overfill prevention equipment because they should not be receiving fuel deliveries.*

*People can be killed or injured while closing or removing tanks. Use safe removal practices; see [www.epa.gov/ust/resources-owners-and-operators#closing](http://www.epa.gov/ust/resources-owners-and-operators#closing) for a safe closure standard. Only trained professionals should close or remove USTs.*



# What Records Must You Keep?



You must keep records that you can provide to an inspector during an inspection and prove your facility meets certain requirements. Check with your implementing agency to determine if there are additional records you must keep.

	<b>You Must Keep These Records:</b>	<b>For This Long:</b>
	<b>Spill And Overfill Prevention</b>	
<b>UPDATED</b>	<b>Testing and inspection records for spill and overfill prevention equipment and containment sumps used for interstitial monitoring of piping (beginning on October 13, 2018)</b>	<b>Three years</b>
	<b>Corrosion Protection</b>	
	Records of your 60-day inspections for your impressed current corrosion protection system	Three most recent inspections
	Records of cathodic protection tests for your corrosion protection system	Two most recent tests
	<b>Release Detection</b>	
	30-day monitoring results	One year
	Tightness test results	Until the next test
<b>UPDATED</b>	<b>Records for your annual release detection equipment operability tests (beginning on October 13, 2018)</b>	<b>Three years</b>
	Copies of performance claims provided by release detection equipment manufacturers or equipment installers	Five years
	Records of maintenance, repair, and calibration of on-site release detection equipment	One year after servicing is completed
<b>UPDATED</b>	<b>If you use vapor monitoring or groundwater monitoring, records of a site assessment showing that the monitoring system is set up properly (beginning on October 13, 2018)</b>	<b>For as long as vapor monitoring or groundwater monitoring is used</b>
	<b>Walkthrough Inspections</b>	
<b>UPDATED</b>	<b>Records showing you performed periodic walkthrough inspections (beginning on October 13, 2018)</b>	<b>One year</b>
	<b>Compatibility</b>	
<b>UPDATED</b>	<b>If you store certain biofuels or other substances identified by your implementing agency, records demonstrating compliance with the compatibility requirement</b>	<b>For as long as the UST system stores the regulated substance</b>
	<b>Operator Training</b>	
<b>UPDATED</b>	<b>Records for each designated Class A, B, and C operator showing they have been trained (beginning on October 13, 2018)</b>	<b>For as long as the operator is designated at the facility</b>
	<b>Repairs</b>	
	Records showing that a repaired UST system was properly repaired	Until the UST system is permanently closed or undergoes a change-in-service
	<b>Financial Responsibility</b>	
	Records that document you have financial responsibility, as explained in EPA's booklet, <i>Dollars And Sense</i> <a href="http://www.epa.gov/ust/dollars-and-sense-financial-responsibility-requirements-underground-storage-tanks">www.epa.gov/ust/dollars-and-sense-financial-responsibility-requirements-underground-storage-tanks</a>	Until the UST system is permanently closed or undergoes a change-in-service
	<b>Closure</b>	
	Records of the site assessment results required for permanent closure	For at least three years after closing an UST

# For Hazardous Substance USTs Only



Section 101(14) of the Comprehensive Environmental Response, Compensation, and Liability Act of 1980 (CERCLA) designated hundreds of substances as hazardous.

The federal UST regulation applies to the same hazardous substances designated in CERCLA, except for those listed as hazardous wastes. These hazardous wastes are already regulated under Subtitle C of the Resource Conservation and Recovery Act and are not covered by the federal UST regulation. See 40 CFR parts 260-270 for hazardous waste regulations. Information on CERCLA hazardous substances is available from EPA's Superfund Information Center at 800-424-9346.

## What Requirements Apply To Hazardous Substance USTs?

Hazardous substance USTs must meet the same requirements described earlier concerning correct installation; spill, overfill and corrosion protection; corrective action; and closure. See pages 3-27 and 29-33.

In addition, hazardous substance USTs must have secondary containment and interstitial monitoring for release detection, as described below.

### ***Secondary Containment***

Hazardous substance USTs must have secondary containment. A single-walled tank is the first (primary) containment. Using only primary containment, a leak can escape into the environment. But by enclosing an UST within a second wall, leaks can be contained and detected quickly before harming the environment.

There are several ways to construct secondary containment:

- Placing one tank inside another tank or one pipe inside another pipe, making them double-walled systems.
- Placing the UST system inside a concrete vault.

---

Hazardous substance USTs must have secondary containment and interstitial monitoring.

---

- Lining the excavation zone around the UST system with a liner that the hazardous substance cannot penetrate.

### ***Interstitial Monitoring***

A hazardous substance UST must have a release detection system that can indicate the presence of a leak in the confined space between the first and the second wall. Several devices are available to monitor this confined interstitial space. Interstitial means between the walls. The federal UST regulation describes these various methods and the requirements for their proper use.

For hazardous substance USTs installed on or before October 13, 2015, you could have applied for an exception, called a variance, from the requirement for secondary containment and interstitial monitoring. **Variances are not available for hazardous substance USTs installed after October 13, 2015.**

UPDATED

### **What If You Have A Hazardous Substance Release?**

You must follow the same short-term and long-term actions for petroleum releases described on page 30, with two exceptions.

First, you must immediately report hazardous substance spills or overfills that meet or exceed their reportable quantities to the National Response Center at 800-424-8802.

Second, you must also report hazardous substance spills or overfills that meet or exceed reportable quantities to your implementing agency within 24 hours.

However, if spills or overfills are smaller than their reportable quantities and are immediately contained and cleaned up, you do not need to report them. You can get information on reportable quantities by calling EPA's Superfund Information Center at 800-424-9346.

## Links For More Information



### Government Links

- U.S. Environmental Protection Agency's Office of Underground Storage Tanks:  
[www.epa.gov/ust](http://www.epa.gov/ust). EPA's UST compliance assistance: [www.epa.gov/ust/resources-owners-and-operators](http://www.epa.gov/ust/resources-owners-and-operators)
- State UST program contact information:  
[www.epa.gov/ust/underground-storage-tank-ust-contacts#states](http://www.epa.gov/ust/underground-storage-tank-ust-contacts#states)
- Tanks Subcommittee of the Association of State and Territorial Solid Waste Management Officials (ASTSWMO): [www.astswmo.org](http://www.astswmo.org)
- New England Interstate Water Pollution Control Commission (NEIWPCC): [www.neiwpcc.org](http://www.neiwpcc.org)

### Industry Codes And Standards

[www.epa.gov/ust/underground-storage-tanks-usts-laws-regulations#code](http://www.epa.gov/ust/underground-storage-tanks-usts-laws-regulations#code)

### Other Organizations To Contact For UST Information

[www.epa.gov/ust/underground-storage-tank-ust-contacts#other](http://www.epa.gov/ust/underground-storage-tank-ust-contacts#other)



**United States Environmental Protection Agency  
5401P  
Washington, DC 20460**

**EPA 510-K-15-001  
November 2015**